



DESIGNER DOORS
ALUMINIUM & WOOD

Standard Product List

📍 Unit 73 Trevallyn Park West.
95 Hyskraan Close KyaSand.
Johannesburg 2118.

☎ 082 298 4342 / 011 026 1162

✉ info@designdoors.co.za





📍 Unit 73 Trevallyn Park West, 95 Hyskraan Close KyaSand, Johannesburg 2118.

☎ 082 298 4342 / 011 026 1162

✉ info@designdoors.co.za

Banking Details:

FNB ~ Designer Aluminium

62747140135

Cheque

Northgate branch

We also produce custom designs and sizes. Please contact us for a quote

Designer Doors

Standard Product List

Page 2 : Top Hung Casement Windows

Page 3 : Side Hung Casement Windows

Page 4 : Patio and Palace Sliding Doors

Page 5 : Hinge Doors, Arches & Sliding Windows

Page 6 : Vistafold Stacking Folding Doors

Page 7 : Terms and Conditions

DESIGNER DOORS
ALUMINIUM & WOOD

Unit 73 Trevallyn Park West, 95 Hyskraan Close KyaSand, Johannesburg 2118.

082 298 4342 / 011 026 1162

info@designdoors.co.za

Banking Details:

FNB ~ Designer Aluminium

62747140135

Cheque

Northgate branch



PRODUCT LIST

Casement 30.5 Top Hung Windows

We also produce custom designs and sizes. Please contact us for a quote

	590mm	890mm	1190mm	1490mm	1790mm	2090mm	2390mm
590mm	PT0606	PT0906	PT1206	PT1506	PTT1806	PTT2106	PTT2406
890mm	PT0609	PT0909	PT1209	PT1509	PTT1809	PTT2109	PTT2409
1190mm	PT0612	PT0912	PTT1212	PTT1512	PTT1812	PTT2112	PTT2412
1190mm					P4T1812	P4T2112	P4T2412
1490mm	PTT0615	PTT0915	PTT1215	PTT1515	PTT1815	PTT2115	PTT2415
1490mm					P4T1815	P4T2115	P4T2415
1790mm	PTT0618	PTT0918	PTT1218	PTT1518	PTT1818	PTT2118	PTT2418
1790mm					P4T1818	P4T2118	P4T2418

**"SG" indicates Safety Glass

*For obscure glass please add 8%

*Prices are valid for standard finishes: "white, bronze, charcoal, natural".

*Fixing Lugs included for fitment

*Unless specified opener orientation (left / right) is as per diagram. Viewed from outside

*For 6.38 Laminated Safety Glass throughout please add 12%

*For burglar bars add R150 per vent.

*Prices are VAT exclusive and Ex-Factory

Designer Doors Standard Terms and Conditions Apply,
we retain the right to update and change the contents of this pricelist with reasonable notice.



Unit 73 Trevallyn Park West, 95 Hyskraan Close KyaSand, Johannesburg 2118.

082 298 4342 / 011 026 1162

info@designdoors.co.za

Banking Details:

FNB ~ Designer Aluminium

62747140135

Cheque

Northgate branch

PRODUCT LIST

Casement 30.5 Side Hung Windows

We also produce custom designs and sizes. Please contact us for a quote

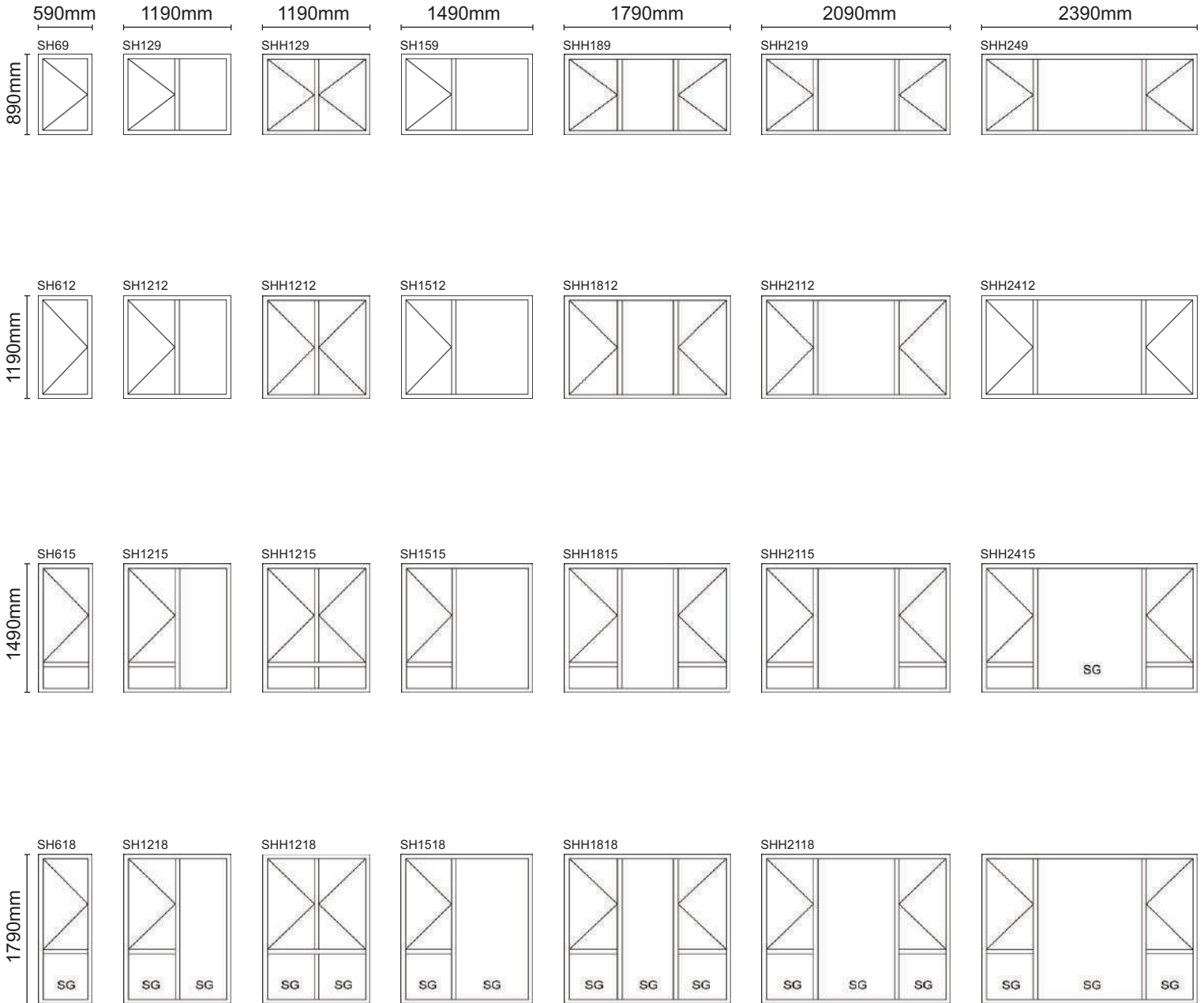

SG indicates Safety Glass

*For obscure glass please add 8%

*Prices are valid for standard finishes: "white, bronze, charcoal, natural".

*Fixing Lugs included for fitment

*Unless specified opener orientation (left / right) is as per diagram. Viewed from outside

*For 6.38 Laminated Safety Glass throughout please add 12%

*For Burglar Bars add R195 per 900mm high vent and R220 for 1200mm

*Prices are VAT exclusive and Ex-Factory

Designer Doors Standard Terms and Conditions Apply,

we retain the right to update and change the contents of this pricelist with reasonable notice.

PRODUCT LIST

Patio and Palace Sliding doors

We also produce custom designs and sizes. Please contact us for a quote

Patio Sliding Doors

OX

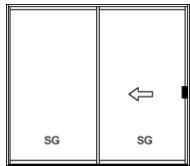

Height (mm)

2090	
1490	SDOX1521
1790	SDOX1821
2090	SDOX2121
2390	SDOX2421
2690	SDOX2721
2990	SDOX3021

Width (mm)

OXX



Height (mm)

2090	
2390	SDOXX2421
2690	SDOXX2721
2990	SDOXX3021
3590	SDOXX3621
4190	SDOXX4221

Width (mm)

OXXO

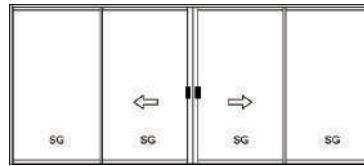

Height (mm)

2090	
2990	SDOXXO3021
3590	SDOXXO3621
4190	SDOXXO4221
4790	SDOXXO4821
5390	SDOXXO5421
5990	SDOXXO6021

Width (mm)

Sidelight Options

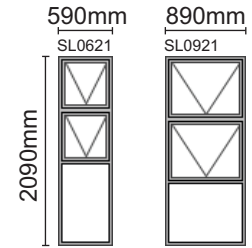

Palace High Performance Sliding Doors

OX

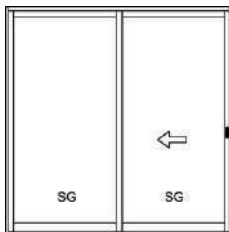

Height (mm)

2090			2390		
1490	PALOX1521	PALOX1524			
1790	PALOX1821	PALOX1824			
2090	PALOX2121	PALOX2124			
2390	PALOX2421	PALOX2424			
2690	PALOX2721	PALOX2724			
2990	PALOX3021	PALOX3024			

Width (mm)

OXX

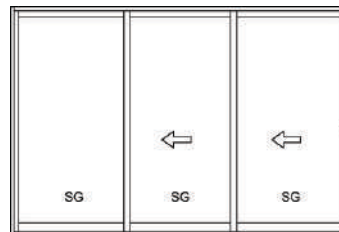

Height (mm)

2090			2390		
2390	PALOXX2421	PALOXX2424			
2690	PALOXX2721	PALOXX2724			
2990	PALOXX3021	PALOXX3024			
3590	PALOXX3621	PALOXX3624			
4190	PALOXX4221	PALOXX4224			

Width (mm)

OXXO

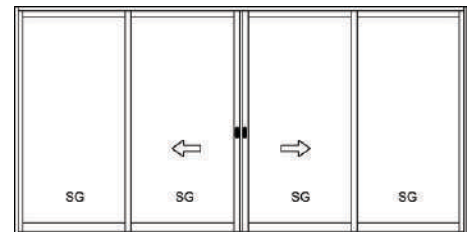

Height (mm)

2090			2390		
2990	PALOXXO3021	PALOXXO3024			
3590	PALOXXO3621	PALOXXO3624			
4190	PALOXXO4221	PALOXXO4224			
4790	PALOXXO4821	PALOXXO4824			
5390	PALOXXO5421	PALOXXO5424			
5990	PALOXXO6021	PALOXXO6024			

Width (mm)

*All glass is Safety Glass

**"O" = fixed and "X" = Sliding

*Viewed from the outside, please specify handle orientation "Handle left/right".

*Prices are valid for standard finishes "white, bronze, charcoal, natural"

*For 'All Panels Sliding' (ie XX or XXX or XXXX) on the Palace Door please add 17%

*For product coding "ww" = width ie (27 for 2.7m) and "hh" = height (ie 21 for 2.1m)

*Prices are VAT exclusive and Ex-Factory

Designer Doors Standard Terms and Conditions Apply,

we retain the right to update and change the contents of this pricelist with reasonable notice.

PRODUCT LIST

Hinge Doors, Arches & Sliding Windows

We also produce custom designs and sizes. Please contact us for a quote

Hinge Doors

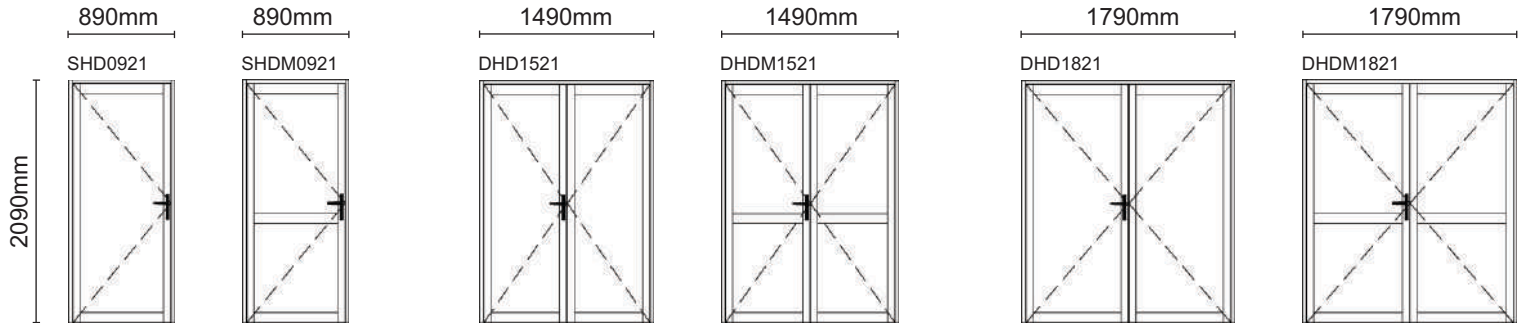

Shopfront Arches

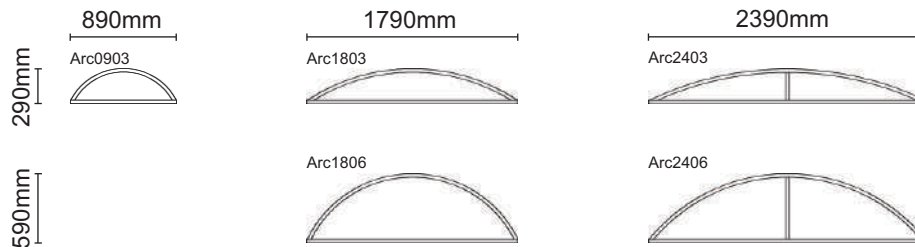

Horizontal Sliding Windows ('Elite' System)

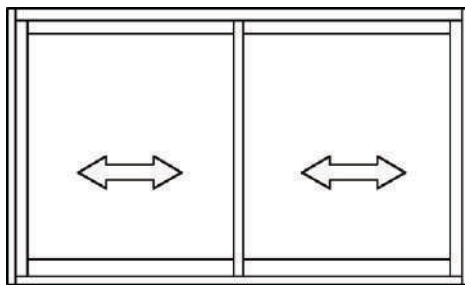

		Height (mm)	
		590	890
		Ref	Ref
Width (mm)	890	HS96	HS0909
	1190	HS1206	HS1209
	1490	HS1506	HS1509

Vertical Sliding Windows

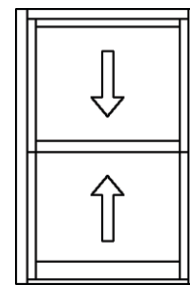

		Height (mm)		
		890	1190	1490
		Ref	Ref	Ref
Width (mm)	590	VS0609	VS0612	VS0615
	890	VS0909	VS0912	VS0915

**"SG" indicates 'Safety Glass'

*For obscure safety glass glass please add 10%

*Prices are valid for standard finishes "white, bronze, charcoal, natural"

*For Single Hinge Doors: Viewed from the outside, please specify handle orientation "Handle left/right".

*Unless specified all doors are assumed to be opening out with a threshold.

*All arches are fitted on top of a straight shopfront section.

*Prices are VAT exclusive and Ex-Factory
Designer Doors Standard Terms and Conditions Apply,
we retain the right to update and change the contents of this pricelist with reasonable notice.

PRODUCT LIST

Vistafold Stacking Folding Doors

We also produce custom designs and sizes. Please contact us for a quote

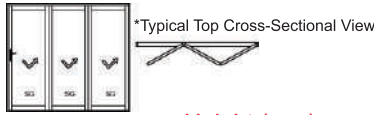

3 Panel

Height (mm)

Width (mm)

	1800-2100	2101-2400	2401-2700
Up to 1800	SF1821-3	SF1824-3	SF1827-3
1801-2100	SF2121-3	SF2124-3	SF2127-3
2101-2400	SF2421-3	SF2424-3	SF2427-3
2401-2700	SF2721-3	SF2724-3	SF2727-3

Product Coding : SF ww hh - 3

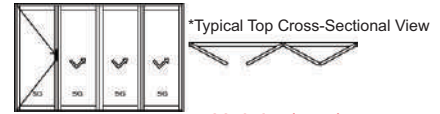

4 Panel (3+1)

Height (mm)

Width (mm)

	1800-2100	2101-2400	2401-2700
2401-2700	SF2721-4	SF2724-4	SF2727-4
2701-3000	SF3021-4	SF3024-4	SF3027-4
3001-3300	SF3321-4	SF3324-4	SF3327-4
3301-3600	SF3621-4	SF3624-4	SF3627-4

Product Coding : SF ww hh - 3+1

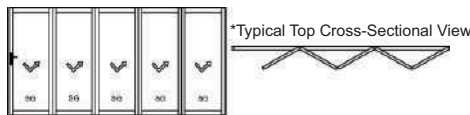

5 Panel

Height (mm)

Width (mm)

	1800-2100	2101-2400	2401-2700
3001-3300	SF3321-5	SF3324-5	SF3327-5
3301-3600	SF3621-5	SF3624-5	SF3627-5
3601-3900	SF3921-5	SF3924-5	SF3927-5
3901-4200	SF4221-5	SF4224-5	SF4227-5
4201-4500	SF4521-5	SF4524-5	SF4527-5

Product Coding : SF ww hh - 5

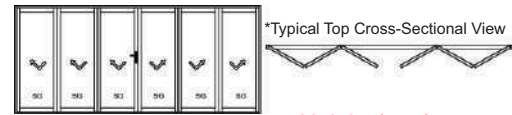

6 Panel (3+3 or 5+1)

Height (mm)

Width (mm)

	1800-2100	2101-2400	2401-2700
3600-3900	SF3921-6	SF3924-6	SF3927-6
3901-4200	SF4221-6	SF4224-6	SF4227-6
4201-4500	SF4521-6	SF4524-6	SF4527-6
4501-4800	SF4821-6	SF4824-6	SF4827-6
4801-5100	SF5121-6	SF5124-6	SF5127-6
5101-5400	SF5421-6	SF5424-6	SF5427-6

Product Coding : SF ww hh - 3+3 or 5+1

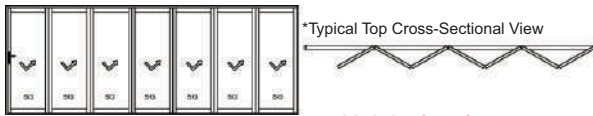

7 Panel

Height (mm)

Width (mm)

	1800-2100	2101-2400	2401-2700
4201-4500	SF4521-7	SF4524-7	SF4527-7
4501-4800	SF4821-7	SF4824-7	SF4827-7
4801-5100	SF5121-7	SF5124-7	SF5127-7
5101-5400	SF5421-7	SF5424-7	SF5427-7
5401-5700	SF5721-7	SF5724-7	SF5727-7
5701-6000	SF6021-7	SF6024-7	SF6027-7
6001-6300	SF6321-7	SF6324-7	SF6327-7

Product Coding : SF ww hh - 7

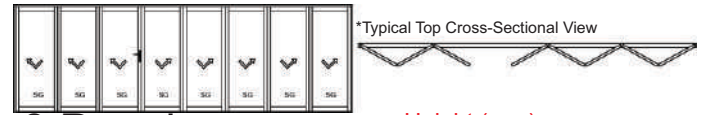

8 Panel (7+1 or 5+3)

Height (mm)

Width (mm)

	1800-2100	2101-2400	2401-2700
4801-5100	SF5121-8	SF5124-8	SF5127-8
5101-5400	SF5421-8	SF5424-8	SF5427-8
5401-5700	SF5721-8	SF5724-8	SF5727-8
5701-6000	SF6021-8	SF6024-8	SF6027-8
6001-6300	SF6321-8	SF6324-8	SF6327-8
6301-6600	SF6621-8	SF6624-8	SF6627-8
6601-6900	SF6921-8	SF6924-8	SF6927-8
6901-7200	SF7221-8	SF7224-8	SF7227-8

Product Coding : SF ww hh - 7+1 or 5+3



9 Panel

Height (mm)

Width (mm)

	1800-2100	2101-2400	2401-2700
5400-5700	SF5721-9	SF5724-9	SF5727-9
5701-6000	SF6021-9	SF6024-9	SF6027-9
6001-6300	SF6321-9	SF6324-9	SF6327-9
6301-6600	SF6621-9	SF6624-9	SF6627-9
6601-7200	SF7221-9	SF7224-9	SF7227-9
7201-7800	SF7821-9	SF7824-9	SF7827-9
7801-8400	SF8421-9	SF8424-9	SF8427-9

Product Coding : SF ww hh - 9

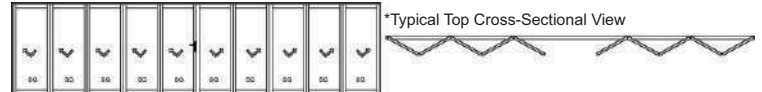

10 Panel (9+1 or 5+5)

Height (mm)

Width (mm)

	1800-2100	2101-2400	2401-2700
6001-6300	SF6321-10	SF6324-10	SF6327-10
6301-6600	SF6621-10	SF6624-10	SF6627-10
6601-6900	SF6921-10	SF6924-10	SF6927-10
6901-7200	SF7221-10	SF7224-10	SF7227-10
7201-7800	SF7821-10	SF7824-10	SF7827-10
7801-8400	SF8421-10	SF8424-10	SF8427-10
8401-9000	SF9021-10	SF9024-10	SF9027-10

Product Coding : SF ww hh - 9+1 or 5+5

*All glass is Safety Glass

*Viewed from the outside, please specify handle orientation "Handle left/right" and panel configuration (ie "3" or "3+1" or "5+5" etc).

*Prices are valid for standard finishes "white, bronze, charcoal, natural"

*For a Cas30.5 PTT insert add R2000 for 2100mm, R2150 for 2400mm and R2320 for 2700mm

*For special designs (2+2 Duo, 4+4 Duo, 3m high mullion Vista or corner entry doors) please request a quote

*For product coding "ww" = width ie (27 for 2.7m) and "hh" = height (ie 21 for 2.1m)

*Prices are VAT exclusive and Ex-Factory

Designer Doors Standard Terms and Conditions Apply,

we retain the right to update and change the contents of this pricelist with reasonable notice.



Unit 73 Trevallyn Park West, 95 Hyskraan Close KyaSand, Johannesburg 2118.

082 298 4342 / 011 026 1162

info@designdoors.co.za

Banking Details:

FNB ~ Designer Aluminium

62747140135

Cheque

Northgate branch

We also produce custom designs and sizes. Please contact us for a quote

Designer Doors

Standard Product List - Terms and Conditions

Leadtime & Delivery

- Manufacturing lead time is a function of order size, current order book and product complexity. For leadtime crucial orders please check with us before ordering.
- For standard size products, in one of the standard colours and standard single clear glazing the following estimates can be used:
 - o 1-4 windows or 2 doors or 1 stacking door – 4 working days
 - o 5-10 windows or 4 doors or 2-3 stacking doors – 7 working days
 - o Mixed order < R50 000 – 10 working Days
 - o Orders larger than R50 000 please enquire for specific leadtime.
- A complete order is regarded as a signed quotation with sizes and designs finalized.
- Non-standard finishes, Special glazing, Double Glazing, special hardware requirements or any design deviation from the standard pricelist will affect the delivery lead times and are not always in the control of **Designer Doors**.
- Any revisions or changes to original order could necessitate a review of the quoted lead time.
- A final delivery and installation date will be confirmed once all products have been manufactured.
- Prices are quoted Ex-Factory collection. Delivery can be requested and quoted separately.
- Products (Aluminium and Glass) are covered by protective tape and film. Any additional packaging requirements will be separately quoted on request.

Payment terms

- A 50% deposit is payable and forms part of the acceptance of this quote and confirmation of order.
- The balance is payable on completion of the manufacturing process and prior to collection or delivery.
- Completed products can be inspected at our factory prior to final payment should you wish to do so.
- **Designer Doors** does not agree to a retention amount.
- In the event of cancellation or amendment of the order by the client, a cancellation fee shall apply.
- Any other payment terms need to be specifically agreed and will follow our other relevant policies.

Quality Guaranteed

- Product quality should be inspected by client on acceptance of the products.
- **Designer Doors** Johannesburg North guarantees all its products for a period of 12 months against latent defect and workmanship. The defective product or component will be replaced Ex-Factory.
- Products are designed to conform to national building standards and AAAMSA standards.
- All products are manufactured from SABS approved materials.
- Glazing is according to SA Glazing standards. We are unable to furnish a SAGGA glazing certificate for Supply-Only products. We can provide a **Designer Doors** manufacturing certificate on request.
- Intruderprufe® glazing carries a 30 year warranty.
- Powder coated and anodised finishes carry a 10 year guarantee (refer relevant SABS Code)
- Hardware warranties differ from brand to brand and are subject to the specific application.

Other

- The quotation is based on the sizes of product quoted exactly as per pricelist. Sizes indicated on the Design specification are actual sizes. It is recommended that actual sizes are 10 mm smaller than opening sizes.
- It is recommended that apertures of the building are measured after the building process is completed and before the final order is placed on **Designer Doors**. A 10mm tolerance from opening size is recommended.
- Fixing lugs for casement windows are included but excluded are all screws, anchors, installation packers, silicone or any other consumables that could be required in the installation process.